

# AVE

L I G H T I N G

HF9231-BLK

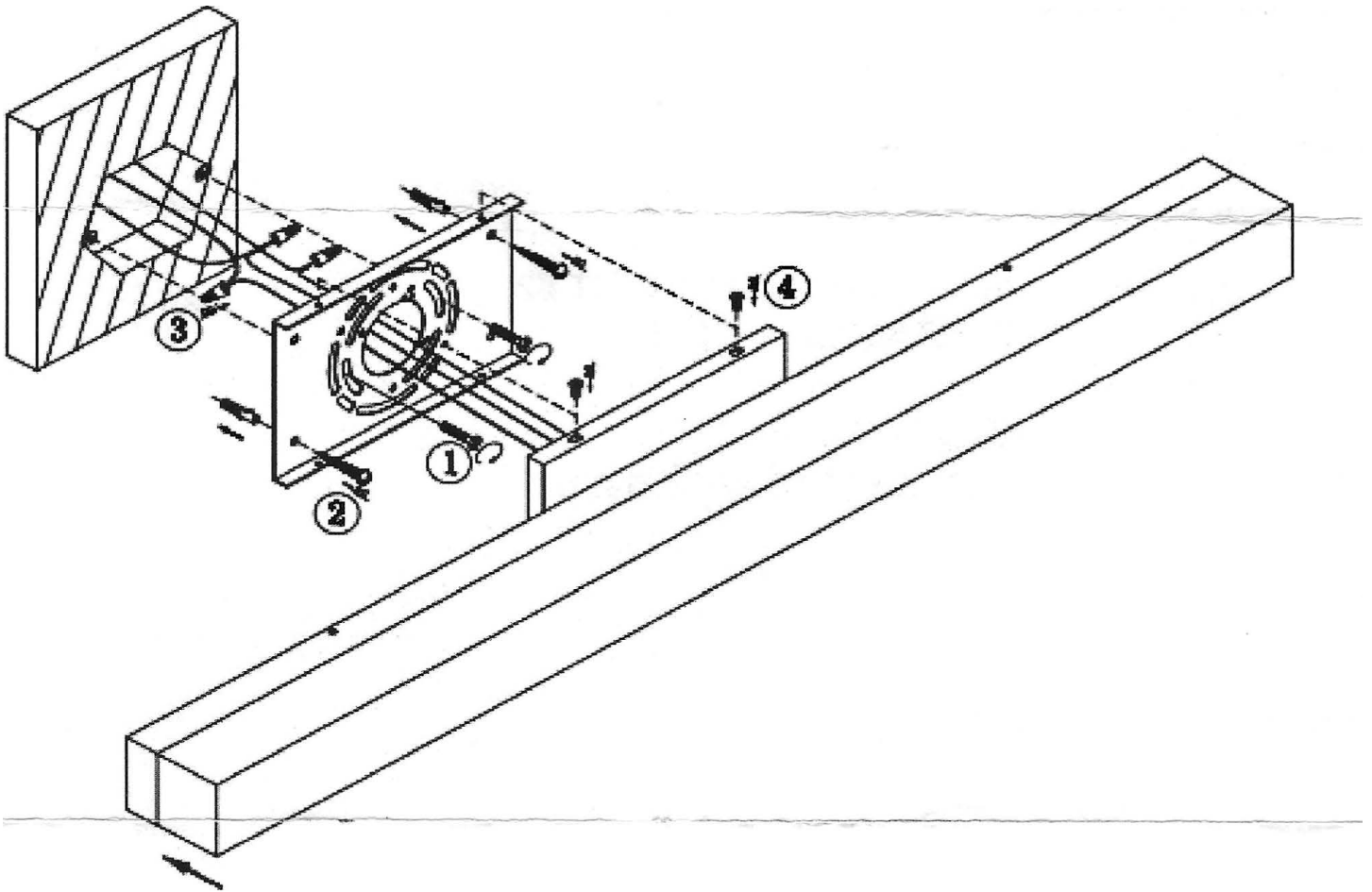

**A:**Copper ground wire to ground wire-if you only have two wires coming from the electrical box,connect the fixture's copper wire to the green ground screw on the mounting plate.

**B:**White fixture wire to white supply wire.

**C:**Black Fixture wire to black supply wire.